

STIHL

Chain Saw Safety Manual



WARNING

Read Instruction Manual thoroughly before use and follow all safety precautions – improper use can cause serious or fatal injury.

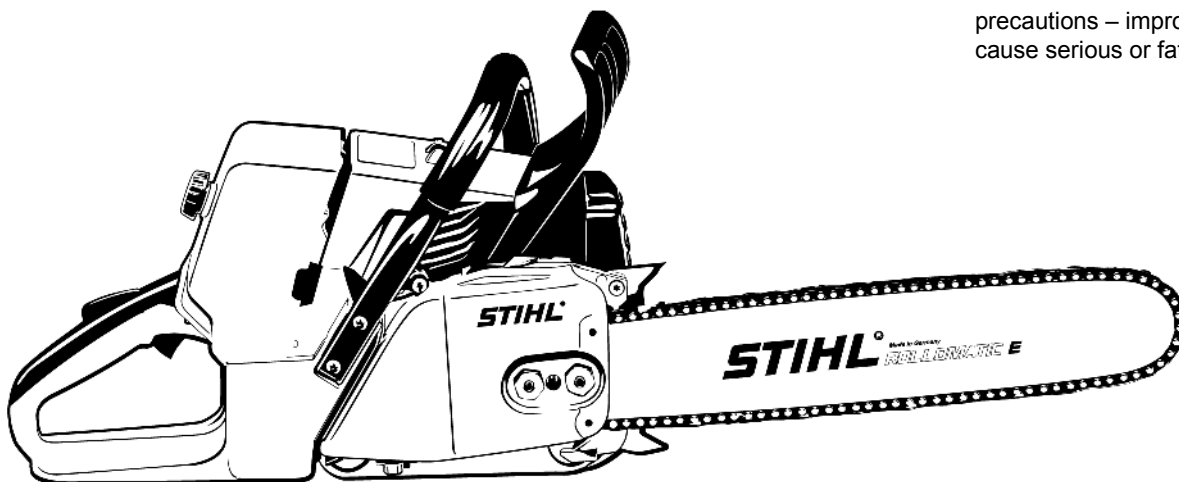

Contents

Safety Precautions	2
Reactive Forces	15
Working Techniques	20
Maintenance and Care	27
Main Parts	29

This manual contains the safety precautions and recommended cutting techniques outlined in STIHL instruction manuals for gasoline-powered chain saws. Even if you are an experienced chain saw user, it is in your own interest to familiarize yourself with the latest instructions and safety precautions regarding your chain saw.

Please note that the illustrations in the chapter "Main Parts of the Saw" in this manual show the chain saws STIHL MS 171, 181, 211.

Other chain saw models may have different parts and controls. You should therefore always refer to the instruction manual of your particular saw model.

Contact your STIHL dealer or the STIHL distributor for your area if you do not understand any of the instructions in this manual.

WARNING

Avoid contact of bar tip with any object. This can cause the guide bar to kick suddenly up and back, which may result in serious or fatal injury. To reduce the risk of kickback injury STIHL recommends the use of STIHL green labeled reduced kickback bars and low kickback chains and a STIHL Quickstop chain brake.

STIHL

This instruction manual is protected by copyright. All rights reserved, especially the rights to reproduce, translate and process with electronic systems.

Safety Precautions



Because a chain saw is a high-speed, fast-cutting power tool, special safety precautions must be observed to reduce the risk of personal injury.



It is important that you read, fully understand and observe the following safety precautions and warnings. Read the instruction manual and the safety instructions periodically. Careless or improper use may cause serious or fatal injury. Save the instruction manual for future reference.

WARNING

The use of this chain saw may be hazardous. The saw chain has many sharp cutters. If the cutters contact your flesh, they will cut you, even if the chain is not moving.

WARNING

Reactive forces, including kickback, can be dangerous. Pay special attention to the section on reactive forces.

Have your STIHL dealer show you how to operate your chain saw. All safety precautions that are generally observed when working with an axe or a hand saw also apply to the operation of chain saws. Observe all applicable federal, state and local safety regulations, standards and ordinances. When using

a chain saw for logging purposes, for instance, refer to the OSHA regulations for "logging operations" at 29 Code of Federal Regulations 1910.266.

WARNING

Do not lend or rent your chain saw without the instruction manual. Be sure that anyone using it understands the information contained in this manual.

The use of noise emitting chain saws may be restricted to certain times by national, state or local regulations.

Use your chain saw only for cutting wooden objects.

WARNING

Do not use it for other purposes, since misuse may result in personal injury or property damage, including damage to the chain saw.

WARNING

Minors should never be allowed to use this chain saw. Bystanders, especially children, and animals should not be allowed in the area where it is in use.

Most of these safety precautions and warnings apply to the use of all STIHL chain saws. Different models may have different parts and controls. See the appropriate section of your instruction manual for a description of the controls and the function of the parts of your model.

WARNING

Always stop the engine and activate the QuickStop Chainbrake before transporting or carrying out any work on the chain saw. This avoids the risk of the engine starting unintentionally.

STIHL recommends the use of genuine STIHL replacement parts. They are specifically designed to match your model and meet your performance requirements.

Safe use of a chain saw involves

- 1 the operator
- 2 the chain saw
- 3 the use of the chain saw.

THE OPERATOR

Physical Condition

You must be in good physical condition and mental health and not under the influence of any substance (drugs, alcohol, etc.) which might impair vision, dexterity or judgment. Do not operate this chain saw when you are fatigued.

WARNING

Be alert – if you get tired, take a break. Tiredness may result in loss of control. Working with any power tool can be strenuous. If you have any condition that might be aggravated by strenuous work, check with your doctor before operating this chain saw.

WARNING

Prolonged use of a chain saw (or other power tools) exposing the operator to vibrations may produce whitefinger disease (Raynaud's phenomenon) or carpal tunnel syndrome.

These conditions reduce the hand's ability to feel and regulate temperature, produce numbness and burning sensations and may cause nerve and circulation damage and tissue necrosis.

All factors which contribute to whitefinger disease are not known, but cold weather, smoking and diseases or physical conditions that affect blood vessels and blood transport, as well as high vibration levels and long periods of exposure to vibration are mentioned as factors in the development of whitefinger disease. In order to reduce the risk of whitefinger disease and carpal tunnel syndrome, please note the following:

- Most STIHL chain saws are available with an anti-vibration ("AV") system designed to reduce the transmission of vibrations created by the chain saw to the operator's hands. An AV system is recommended for those persons using chain saws on a regular or sustained basis.
- Wear gloves and keep your hands warm. Heated handles, which are available on some STIHL chain saws, are recommended for cold weather use.

- Keep the AV system well maintained. A chain saw with loose components or with damaged or worn AV elements will tend to have higher vibration levels.
- Keep the saw chain sharp and well maintained. A dull saw chain will increase cutting time, and pressing a dull saw chain through wood will increase the vibrations transmitted to your hands.
- Maintain a firm grip at all times, but do not squeeze the handles with constant, excessive pressure. Take frequent breaks.

All the above-mentioned precautions do not guarantee that you will not sustain whitefinger disease or carpal tunnel syndrome. Therefore, continual and regular users should closely monitor the condition of their hands and fingers. If any of the above symptoms appear, seek medical advice immediately.

WARNING

The ignition system of the STIHL unit produces an electromagnetic field of a very low intensity. This field may interfere with some pacemakers. To reduce the risk of serious or fatal injury, persons with a pacemaker should consult their physician and the pacemaker manufacturer before operating this chain saw.

Proper Clothing

WARNING

To reduce the risk of injury, the operator should wear proper protective apparel.



Clothing must be sturdy and snug-fitting, but allow complete freedom of movement. To reduce the risk of cut injuries, wear the type of overalls, long pants or chaps that contain pads of cut-retardant material. Avoid loose-fitting jackets, scarfs, neckties, jewelry, flared or cuffed pants, unconfined long hair or anything that could become caught on branches, brush or the moving parts of the chain saw. Secure hair so it is above shoulder level..



Good footing is very important. Wear sturdy boots with nonslip soles. Steel-toed safety boots are recommended. Never wear sandals, flip-flops or go barefoot.



Always wear heavy-duty work gloves (e.g. made of leather or wear resistant material) when handling the chain saw and the cutting tool. Heavy-duty, nonslip gloves improve your grip and help to protect your hands.



To reduce the risk of injury to your eyes never operate your power tool unless wearing goggles or properly fitted protective glasses with adequate top and side protection complying with ANSI Z87 "+" (or your applicable national standard). If there is a risk of injury to your face, STIHL recommends that you also wear a face shield or face screen over your goggles or protective glasses.

Wear an approved safety hard hat to reduce the risk of injury to your head. Chain saw noise may damage your hearing. Wear sound barriers (ear plugs or ear muffs) to help protect your hearing. Continual and regular users should have their hearing checked regularly.

Be particularly alert and cautious when wearing hearing protection because your ability to hear warnings (shouts, alarms, etc.) is restricted.

THE CHAIN SAW

For illustrations and definitions of the chain saw parts see the chapter on "Main Parts."

WARNING

Never modify this chain saw in any way. Only attachments supplied by STIHL or expressly approved by STIHL for use with the specific STIHL model are authorized. Although certain unauthorized attachments are useable with STIHL chain saws, their use may, in fact, be extremely dangerous.

WARNING

Never operate your chain saw if it is damaged, improperly adjusted or maintained, or not completely and securely assembled.

If this chain saw is subjected to unusually high loads for which it was not designed (e.g. heavy impact or a fall), always check that it is in good condition before continuing work. Check in particular that the fuel system is tight (no leaks) and that the controls and safety devices are working properly. Do not continue operating this chain saw if it is damaged. In case of doubt, have it checked by your STIHL servicing dealer.

THE USE OF THE CHAIN SAW

Transporting the Chain Saw

WARNING

Always stop the engine before putting the chain saw down. Carrying a chain saw with the engine running may be extremely dangerous.

Accidental acceleration of the engine can cause the saw chain to rotate. Always engage the chain brake when taking more than a few steps.

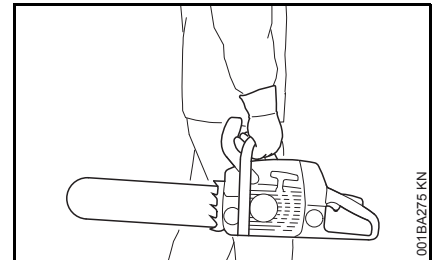

By hand: When transporting your chain saw by hand, the engine must be shut off and the chain saw must be in the proper position, i.e., grip the top handle and place the muffler away from the body; the chain guard (scabbard) should be over the saw chain and guide bar, which should point backwards, away from the direction in which you are walking.

By vehicle: When transporting in a vehicle, keep saw chain and bar covered with the chain guard (scabbard). Properly secure your chain saw to prevent turnover, fuel spillage and damage to the chain saw.

Fuel

Your STIHL chain saw uses an oil-gasoline mixture for fuel (see the "Fuel" chapter in this instruction manual).

! WARNING

Gasoline is an extremely flammable fuel. If spilled and ignited by a spark or other ignition source, it can cause fire and serious burn injury or property damage. Use extreme caution when handling gasoline or fuel mix. Do not smoke or bring any fire or flame near the fuel or the chain saw. Note that combustible fuel vapor may escape from the fuel system.

Fueling Instructions**! WARNING****Pick a Safe Location**

To reduce the risk of fire and explosion, fuel your chain saw in a well-ventilated area, outdoors away from flames, pilot lights, heaters, electric motors, and other sources of ignition. Vapors can be ignited by a spark or flame many feet away. Select bare ground for fueling and move at least 10 feet (3 m) from the fueling spot before starting the engine. Wipe off any spilled fuel before starting your chain saw. Take care not to get fuel on your clothing. If this happens, change your clothing immediately.

Allow the Saw to Cool Before Removing the Fuel Cap**! WARNING**

Gasoline vapor pressure may build up inside the fuel tank. The amount of pressure depends on a number of factors such as the fuel used, altitude and temperature. To reduce the risk of burns and other personal injury from escaping gas, vapor and fumes, always shut off the engine and allow it to cool before removing the fuel cap.

The engine is air cooled. When it is shut off, cooling air is no longer drawn across the cylinder and engine temperatures will rise for several minutes before starting to cool. In hot environments, cooling will take longer. To reduce the risk of burns and other personal injury from escaping gas, vapor and fumes, allow the saw to cool. If you need to refuel before completing a job, turn off the machine and allow the engine to cool before opening the fuel tank.

Fuel Spraying or “Geysering”**! WARNING**

Removing the cap on a pressurized fuel tank can result in gasoline, vapors and fumes being forcefully sprayed out from the fuel tank in all directions. The escaping gasoline, vapors or fumes can cause serious personal injury, including fire and burn injury, or property damage.

Sometimes also referred to as “fuel geysering,” fuel spraying is an expulsion of fuel, vapors and fumes which can occur in hot conditions, or when the engine is hot, and the tank is opened

without allowing the saw to cool adequately. It is more likely to occur when the fuel tank is half full or more.

Pressure is caused by fuel and heat and can occur even if the engine has not been running. When gasoline in the fuel tank is heated (by ambient temperatures, heat from the engine, or other sources), vapor pressure will increase inside the fuel tank.

Some blends of gasoline, particularly those designed for use in winter, are more volatile and may cause tanks to pressurize more quickly or create greater pressure. At higher altitudes, fuel tank pressurization is more likely.

How to Avoid Fuel Spraying

Removing the fuel cap on a pressurized tank can result in gasoline, vapors and fumes being forcefully sprayed out from the fuel tank in all directions. To reduce the risk of burns, serious injuries or property damage from fuel spraying:

- Follow the fueling instructions in this chapter.
- Always assume your fuel tank is pressurized.
- Allow the chain saw to cool before removing the fuel cap.
- In hot environments, cooling will take longer.
- The engine is air cooled. When it is shut off, cooling air is no longer drawn across the cylinder and the engine temperature will rise for several minutes before starting to cool.

After the saw has cooled appropriately, follow the safety instructions in this chapter for removing the cap. Never remove the cap by turning it directly to the open position. First check for residual pressure by turning the cap slowly to the vent position, approximately 1/8 turn counter-clockwise. Use only good quality fuel that is appropriate for the season (summer v. winter blends). Some blends of gasoline, particularly winter blends, are more volatile and can contribute to fuel spraying.

Removing the Toolless Fuel Cap: Turn Slowly and Stop in the Vent Position



WARNING

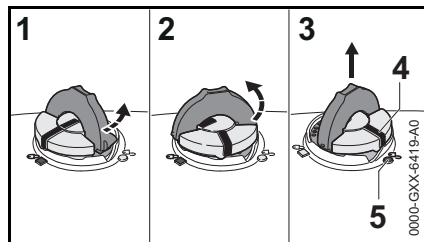

After allowing the chain saw to cool, remove the fuel filler cap slowly and carefully to allow any remaining pressure build-up in the tank to release:

- Flip up the grip and press the cap down firmly (1).
- While maintaining steady, downward pressure, turn the cap slowly counter-clockwise to the vent position (2), approximately a 1/8 turn of the cap.

- If any significant venting occurs, immediately re-seal the tank by turning the cap clockwise to the closed position. Allow the saw to cool further before attempting to open the tank.
- Turn the cap to the open position (3) only after the contents of the tank are no longer under pressure. In the open position, the exterior positioning mark (4) on the cap will line up with the "unlocked" symbol (5) on the fuel tank housing.
- Never remove the cap by turning it directly to the open position. First allow the saw to cool adequately and then release any residual pressure at the vent position (2).
- Never attempt to remove the cap while the engine is still hot or running.

Installing the Toolless Fuel Cap



WARNING

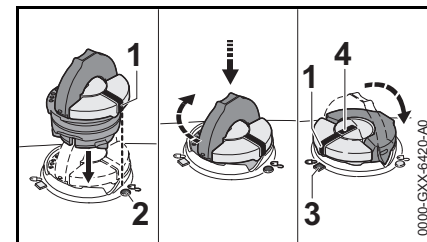

An improperly tightened fuel filler cap can loosen or come off and spill quantities of fuel. To reduce the risk of fuel spillage and fire from an improperly installed fuel cap, correctly position and tighten the cap in the fuel tank opening:

- Raise the grip on the top of the cap until it is upright at a 90° angle. Insert the cap in the fuel tank opening with the exterior positioning mark (1) lined up with the "unlocked" symbol (2) on the fuel tank housing.
- Using the grip, press the cap down firmly while turning it clockwise to the closed position (approximately 1/4 turn). In the closed position, the interior (4) and exterior (1) positioning marks will align with the "locked" symbol (3) on the fuel tank housing.
- Fold the grip flush with the top of the cap and check for tightness.

Misaligned, Damaged or Broken Cap

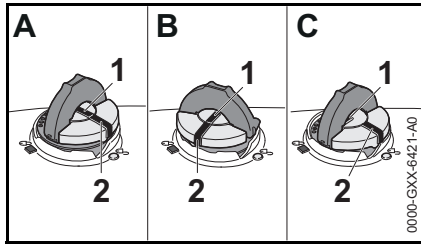
! WARNING

If the cap does not drop fully into the fuel tank opening when the positioning marks (1, 2) line up, or if it does not tighten properly when turned, the base of the cap may be prematurely rotated in relation to the top. Such misalignment can result from handling, cleaning or an improper attempt at tightening.

- Illustrations A and B: The base of the cap is prematurely rotated to the closed position and is not in the correct starting position for installation. The tank will not seal in this configuration. Note: in Illustrations A and B, the interior positioning marks (1) are in line with the exterior position marks (2).
- Illustration C: The bottom of the cap is in the correct starting position for installation. Note: In Illustration C, the interior positioning mark (1) is under the grip and not in line with the outer position mark (2).

To return the base of the cap to the proper starting position for installation:

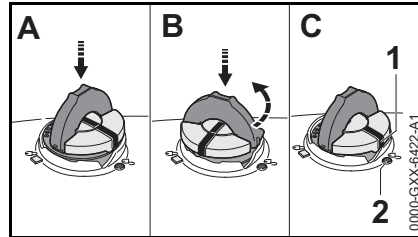

- Drop the cap into the fuel tank opening (A).
- Next, turn the cap counter-clockwise with slight pressure until it drops fully into the fuel tank opening (approximately 1/4 turn) (B). This will rotate the base of the cap into the correct starting position for installation (C). The exterior positioning mark (1) on the cap will line up with the "unlocked" symbol (2) on the fuel tank housing. The interior positioning mark should be under the grip and not in line with the outer positioning mark (1).
- Then, turn the cap clockwise, closing it normally.



If your fuel cap still does not tighten properly, it may be damaged or broken. Stop using the chain saw and take it to your authorized STIHL dealer for repair.

Vapor Lock**! WARNING**

Vapor lock occurs when fuel in the fuel line or carburetor vaporizes, causing bubbles to block the free flow of liquid fuel into the carburetor. Vapor lock cannot be relieved or affected by opening the fuel tank. Removing the fuel filler cap without first allowing the chain saw to cool adequately can result in fuel

spraying. Always follow the instructions in this section when removing the fuel cap.

To relieve vapor lock:

- Place the Master Control Lever in the cold start position  and pull the starter cord approximately 20 times to clear the vapor and send liquid fuel into the carburetor.
- To start the chain saw, move the Master Control Lever to the starting throttle position  and pull the starter cord approximately 10 times.
- If your chain saw will not restart, or if vapor lock occurs again, the chain saw is being used in conditions too extreme for the fuel being used. Discontinue use and let the engine cool completely before attempting to start the chain saw.

Before Operation

Take off the chain guard (scabbard) and inspect the chain saw for proper condition and operation. (See the maintenance chart near the end of the instruction manual.)

! WARNING

Always check your chain saw for proper condition and operation before starting, particularly the throttle trigger, throttle trigger lockout, stop switch and cutting attachment. The throttle trigger must move freely and always spring back to the idle position. The Master Control Lever / stop switch must move easily to **STOP**, 0 or . Never attempt to modify the controls or safety devices.

! WARNING

Check fuel system for leaks, especially the visible parts, e.g., filler cap, hose connections, manual fuel pump (only for chain saws equipped with a manual fuel pump). Do not start the engine if there are leaks or damage – risk of fire. Have the chain saw repaired by a STIHL servicing dealer before using it.

! WARNING

Check that the spark plug boot is securely mounted on the spark plug – a loose boot may cause arcing that could ignite combustible fumes and cause a fire.

For proper assembly of the bar and saw chain follow the procedure described in the chapter "Mounting the Bar and Chain" of your instruction manual. STIHL Oilomatic saw chain, guide bar and sprocket must match each other in gauge and pitch. Before replacing any bar and chain, see the chapter entitled "Specifications" in the instruction manual and the chapter "Reactive Forces including Kickback".

Since longer bars add weight and may be more difficult to control, select the shortest bar that will meet your cutting needs.

! WARNING

Proper tension of the chain is extremely important. In order to avoid improper setting, the tensioning procedure must be followed as described in your manual. Always make sure the hexagonal nut(s) for the sprocket cover is (are) tightened securely after

tensioning the saw chain in order to secure the bar. Never start the chain saw with the sprocket cover loose. Check chain tension once more after having tightened the nut(s) and thereafter at regular intervals (whenever the saw is shut off). If the saw chain becomes loose while cutting, shut off the engine and then tighten. Never try to adjust the saw chain while the engine is running.

! WARNING

After adjusting a saw chain, start the chain saw, let the engine run for a while, then switch engine off and recheck saw chain tension. Proper saw chain tension is very important at all times.

Keep the handles clean and dry at all times; it is particularly important to keep them free of moisture, pitch, oil, fuel mix, grease or resin in order for you to maintain a firm grip and properly control your chain saw .

! WARNING

Be sure that the guide bar and saw chain are clear of you and all other obstructions and objects, including the ground. If the upper quadrant of the tip of the bar touches any object, it may cause kickback to occur (see section on reactive forces). Never attempt to start the chain saw when the guide bar is in a cut or kerf.

For specific starting instructions, see the appropriate section of your instruction manual.

Starting

! WARNING

To reduce the risk of fire and burn injuries, start the engine at least 10 feet (3 m) from the fueling spot, outdoors only.

Start and operate your chain saw without assistance. For specific starting instructions, see the appropriate section of the instruction manual. Proper starting methods reduce the risk of injury.

! WARNING

To reduce the risk of injury from saw chain contact and / or reactive forces, the chain brake must be engaged when starting the chain saw. If your chain saw is equipped with the Quickstop Plus chain brake system, it is not sufficient to engage that brake only for starting, because the saw chain may begin to rotate at high speed when the throttle trigger lockout is depressed (releasing the brake) in order to blip the throttle trigger after starting.

! WARNING

Do not drop start. This method is very dangerous because you may lose control of the chain saw.

There are two recommended methods for starting your chain saw.

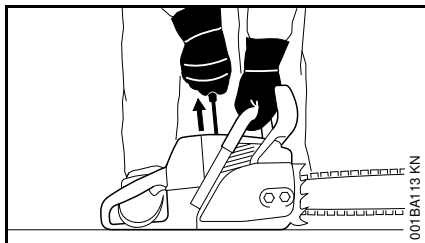

With the **first** recommended **method**, the chain saw is started on the ground. Make sure the chain brake is engaged (see "Chain Brake" chapter in your instruction manual) and place the chain saw on firm ground or other solid surface in an open area. Maintain good balance and secure footing.

Grip the front handlebar of the saw firmly with your left hand and press down. For saws with a rear handle level with the ground, put the toe of your right foot into the rear handle and press down. With your right hand pull out the starter grip slowly until you feel a definite resistance and then give it a brisk, strong pull.

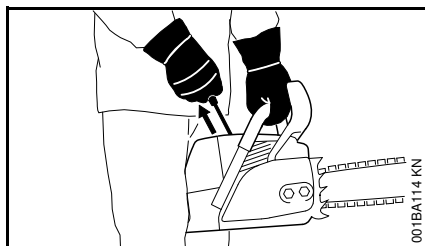

The **second** recommended **method** for starting your chain saw allows you to start the saw without placing it on the ground. Make sure the chain brake is engaged, grip the front handle of the chain saw firmly with your left hand. Keep your arm on the front handle in a locked (straight) position. Hold the rear

handle of the saw tightly between your legs just above the knees. Maintain good balance and secure footing. Pull the starting grip slowly with your right hand until you feel a definite resistance and then give it a brisk, strong pull.

! WARNING

Be sure that the guide bar and saw chain are clear of you and all other obstructions and objects, including the ground. When the engine is started, the engine speed with the starting throttle lock engaged will be fast enough for the clutch to engage the sprocket and, if the chain brake is not activated, turn the saw chain. If the upper quadrant of the tip of the bar touches any object, it may cause kickback to occur (see section on reactive forces). To reduce this risk, always engage the chain brake before starting. Never attempt to start the chain saw when the guide bar is in a cut or kerf.

Once the engine has started, immediately blip the throttle trigger, which should release the Master Control lever to the run position and allow the engine to slow down to idle.

Always disengage chain brake before accelerating engine and before starting cutting work. The only exception to this rule is when you check operation of the chain brake. High revs with the chain brake engaged (chain locked) will quickly damage the powerhead and chain drive (clutch, chain brake).

! WARNING

When you pull the starter grip, do not wrap the starter rope around your hand. Do not let the grip snap back, but guide the starter rope to rewind it properly. Failure to follow this procedure may result in injury to your hand or fingers and may damage the starter mechanism.

Important Adjustments

! WARNING

To reduce the risk of personal injury from loss of control and / or contact with the running cutting tool, do not use your chain saw with incorrect idle adjustment. At correct idle speed, the cutting tool should not move. For directions on how to adjust idle speed, see the appropriate section of your instruction manual.

If you cannot set the correct idle speed, have your STIHL dealer check your chain saw and make proper adjustments and repairs.

Holding and Controlling the Chain Saw

Always hold the chain saw firmly with both hands when the engine is running. Place your left hand on the front handle bar and your right hand on the rear handle and throttle trigger.

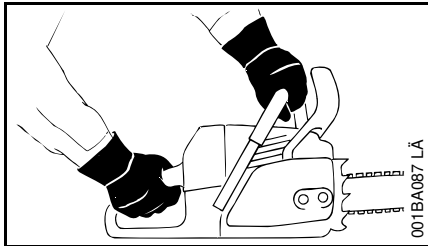

Left-handers should follow these instructions too. Wrap your fingers tightly around the handles, keeping the handles cradled between your thumb and forefinger. With your hands in this position, you can best oppose and absorb the push, pull and kickback forces of your saw without losing control (see section on reactive forces).

! WARNING



To reduce the risk of serious or fatal injury to the operator or bystanders from loss of control, never use the chain saw with one hand. It is more difficult for you to control reactive forces and to prevent the bar and chain from skating or bouncing along the limb or log.

! WARNING

To reduce the risk of cut injuries, keep hands and feet away from the cutting tool. Never touch a moving cutting tool with your hand or any other part of your body.

! WARNING

Keep proper footing and balance at all times. Special care must be taken in slippery conditions (wet ground, snow) and in difficult, overgrown terrain. Be extremely cautious when working on slopes or uneven ground. Watch for hidden obstacles such as tree stumps, roots, rocks, holes and ditches to avoid stumbling. There is increased danger of slipping on freshly debarked logs. For better footing, clear away fallen branches, scrub and cuttings. Use extreme caution when cutting small-size brush, branches and saplings because slender material may catch the saw chain and be whipped toward you or pull you off balance.

! WARNING

Take extreme care in wet and freezing weather (rain, snow, ice). Put off the work when the weather is windy, stormy or rainfall is heavy.

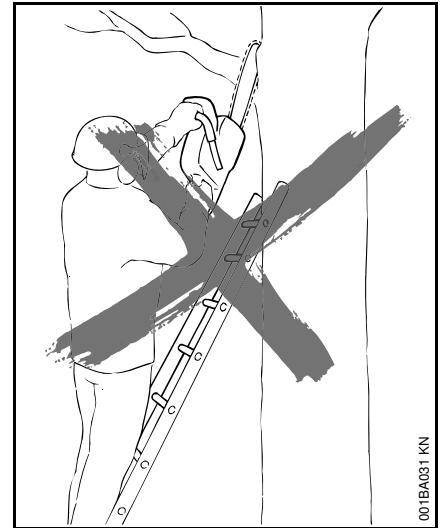

! WARNING

To reduce the risk of injury from loss of control, never work on a ladder or any other insecure support. Never hold the machine above shoulder height. Do not overreach.

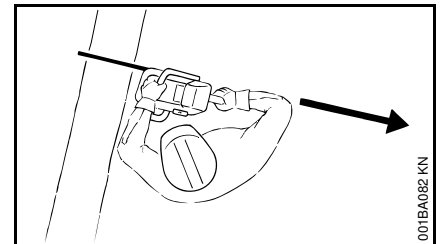

Position the chain saw in such a way that your body is clear of the cutting attachment whenever the engine is running. Stand to the left of cut while bucking.

Never put pressure on the chain saw when reaching the end of a cut. The pressure may cause the bar and rotating saw chain to pop out of the cut or kerf, go out of control and strike the operator or some other object. If the rotating saw chain strikes some other object, a reactive force may cause the moving saw chain to strike the operator.

STIHL recommends that first-time users should cut logs on a sawhorse – see "Cutting small logs."

Working Conditions

Operate and start your chain saw only outdoors in a well-ventilated area. Operate it under good visibility and daylight conditions only. Work carefully.

WARNING

Your chain saw is a one-person machine. Do not allow other persons in the general work area, even when starting. Stop the engine immediately if you are approached.

WARNING

Even though bystanders should be kept away from the running chain saw, never work alone. Keep within calling distance of others in case help is needed.

WARNING

To reduce the risk of injury to bystanders and damage to property, never let your chain saw run unattended. When it is not in use (e. g. during a work break), shut it off and make sure that unauthorized persons do not use it.

WARNING



As soon as the engine is running, this product generates toxic exhaust fumes containing chemicals, such as unburned hydrocarbons (including benzene) and carbon monoxide, that are known to cause respiratory problems, cancer, birth defects, or other reproductive harm. Some of the gases (e. g. carbon monoxide) may be colorless and odorless. To reduce the risk of serious or fatal injury/illness from inhaling toxic fumes, never run the machine indoors or in poorly ventilated locations. If exhaust fumes become concentrated due to insufficient ventilation, clear obstructions from work area to permit proper ventilation before proceeding and/or take frequent breaks to allow fumes to dissipate before they become concentrated.

WARNING

Operate your chain saw so that it produces a minimum of noise and emissions – do not run engine unnecessarily and accelerate the engine only for cutting.

WARNING

Use of this chain saw (including sharpening the saw chain) can also generate dust, mist and fumes containing chemicals that are known to cause respiratory problems, cancer, birth defects, or other reproductive harm. If you are unfamiliar with the risks associated with the particular dust, mist or fume at issue, consult your employer, governmental agencies such as OSHA and NIOSH and other sources on hazardous materials. California and some other authorities, for instance, have published lists of substances known to cause cancer, reproductive toxicity, etc.

WARNING

Inhalation of certain dusts, especially organic dusts such as mold or pollen, can cause susceptible persons to have an allergic or asthmatic reaction. Substantial or repeated inhalation of dust and other airborne contaminants, in particular those with a smaller particle size, may cause respiratory or other illnesses. This includes wood dust, especially from hardwoods, but also from some softwoods such as Western Red Cedar. Control dust (such as saw dust), mists (such as oil mist from chain lubrication) and engine fumes at the source where possible. Use good work practices, such as always cutting with a properly sharpened saw chain (which produces wood chips rather than fine dust) and operating the unit so that the wind or operating process directs any dust raised by the chain saw away from the operator. Follow the recommendations of

EPA/OSHA/NIOSH and occupational and trade associations with respect to dust ("particulate matter"). When the inhalation of dust cannot be substantially controlled, i.e., kept at or near the ambient (background) level, the operator and any bystanders should wear a respirator approved by NIOSH / MSHA for the type of dust encountered.

WARNING

Breathing asbestos dust is dangerous and can cause severe or fatal injury, respiratory illness or cancer. The use and disposal of asbestos-containing products have been strictly regulated by OSHA and the Environmental Protection Agency. Do not use your chain saw to cut or disturb asbestos or asbestos-containing products. If you have any reason to believe that you might be cutting asbestos, immediately stop cutting and contact your employer or a local OSHA representative.

Operating Instructions

WARNING

Do not operate your chain saw with the starting throttle lock engaged. Cutting with the starting throttle lock engaged does not permit the operator proper control of the chain saw or saw chain speed. Begin and continue cutting with the saw at full throttle, engage the bumper spike firmly in the wood (if possible) and then continue cutting. Always work with the bumper spike so that you have better control of the saw. If you work without the bumper spike the chain saw may pull you forwards suddenly.

WARNING

Never touch a saw chain with your hand or any part of your body when the engine is running, even when the chain is not rotating.

In the event of an emergency, switch off the engine immediately – move the Master Control Lever to **STOP**, 0 or .

WARNING

Always stop the engine before putting the chain saw down.

WARNING

The saw chain continues to move for a short period after the throttle trigger is released (flywheel effect).

Accelerating the engine while the saw chain is blocked increases the load and will cause the clutch to slip continuously. This may occur if the throttle is depressed for more than a few seconds when the saw chain is pinched in the cut or the chain brake is engaged. It can result in overheating and damage to important components (e. g. clutch, polymer housing components) – which can then increase the risk of injury, e. g., from the saw chain moving while the engine is idling.

WARNING

Your chain saw is equipped with a chain catcher. It is designed to reduce the risk of personal injury in the event of a thrown or broken saw chain. From time to time, the catcher may be damaged or

removed. To reduce the risk of personal injury, do not operate a chain saw with a damaged or missing chain catcher.

WARNING

Inspect antivibration elements periodically. Replace damaged, broken or excessively worn antivibration elements immediately, since they may result in loss of control of the saw. A "sponginess" in the feel of the saw, increased vibration or increased "bottoming" during normal operation may indicate damage, breakage or excessive wear. Antivibration elements should always be replaced in sets. If you have any questions as to whether the antivibration elements should be replaced, consult your STIHL servicing dealer.

If this chain saw is subjected to unusually high loads for which it was not designed (e. g. heavy impact or a fall), always check that it is in good condition before continuing work. Check in particular that the fuel system is tight (no leaks) and that the controls and safety devices are working properly. Do not continue operating this chain saw if it is damaged. In case of doubt, have it checked by your STIHL servicing dealer.

Your chain saw is not designed for prying or shoveling away limbs, roots or other objects. Such use could damage the cutting attachment or AV system.

WARNING

When sawing, make sure that the saw chain does not touch any foreign materials such as rocks, fences, nails

and the like. Such objects may be flung off, damage the saw chain or cause the chain saw to kickback.

WARNING

If the rotating saw chain strikes a rock or other hard object, sparks may be created, which can ignite flammable materials under certain circumstances. Flammable materials can include dry vegetation and brush, particularly when weather conditions are hot and dry. Do not use your chain saw around flammable materials or around dry vegetation or brush when there is a risk of fire or wildfire. Contact your local fire authorities or the U.S. Forestry Service if you have any question about whether vegetation and weather conditions are suitable for the use of a chain saw.

WARNING

Take special care when cutting shattered wood because of the risk of injury from splinters being caught and thrown in your direction.

WARNING

Never modify your muffler. Any modification could cause an increase in heat radiation, sparks or sound level, thereby increasing the risk of fire, burn injury or hearing loss. You may also permanently damage the engine. Have your muffler serviced and repaired by your STIHL servicing dealer only.

WARNING

The muffler and other parts of the engine (e.g. fins of the cylinder, spark plug) become hot during operation and remain

hot for a while after stopping the engine. To reduce risk of burns, do not touch the muffler and other parts while they are hot. Keep the area around the muffler clean. Remove excess lubricant and all debris such as pine needles, branches or leaves. Let the engine cool down sitting on concrete, metal, bare ground or solid wood (e.g. the trunk of a felled tree) away from any combustible substances.

WARNING

An improperly mounted or damaged cylinder housing or a damaged/deformed muffler shell may interfere with the cooling process of the muffler. To reduce the risk of fire or burn injury, do not continue work with a damaged or improperly mounted cylinder housing or a damaged/deformed muffler shell.

Your muffler is furnished with a spark arresting screen designed to reduce the risk of fire from the emission of hot particles. Never operate your unit with a missing or damaged spark arresting screen. If your gas/oil mix ratio is correct (i.e., not too rich), this screen will normally stay clean as a result of the heat from the muffler and need no service or maintenance. If you experience loss of performance and you suspect a clogged screen, have your muffler maintained by a STIHL servicing dealer. Some state or federal laws or regulations may require a properly maintained spark arrester for certain uses. See the "Maintenance, Repair and Storing" section of these Safety Precautions. Remember that the risk of a brush or forest fire is greater in hot or dry conditions.

WARNING



Some STIHL chain saws are equipped with a catalytic converter, which is designed to reduce the exhaust emissions of the engine by a chemical process in the muffler. Due to this process, the muffler does not cool down as rapidly as conventional mufflers when the engine returns to idle or is shut off. To reduce the risk of fire and burn injuries when using a catalytic converter, always set your chain saw down in the upright position and never locate it where the muffler is near dry brush, grass, wood chips or other combustible materials while it is still hot.

! DANGER



Do not rely on the chain saw's insulation against electric shock. To reduce the risk of electrocution, never operate this chain saw in the vicinity of any wires or cables (power, etc.) which may be carrying electric current. To reduce risk of **electrocution**, take extra precautions when cutting near power lines. Have the power switched off before starting cutting work in the immediate vicinity of power lines.

MAINTENANCE, REPAIR AND STORING

Maintenance, replacement, or repair of the emission control devices and systems may be performed by any nonroad engine repair establishment or individual. However, if you make a warranty claim for a component which has not been serviced or maintained properly, STIHL may deny coverage.

! WARNING

Use only identical STIHL replacement parts for maintenance and repair. Use of non-STIHL parts may cause serious or fatal injury.

Strictly follow the maintenance and repair instructions in the appropriate section of your instruction manual. Please refer to the maintenance chart in this manual.

! WARNING

Always stop the engine and make sure that the cutting tool is stopped before doing any maintenance or repair work or cleaning the power tool.

! WARNING

Do not attempt any maintenance or repair work not described in your instruction manual. Have such work performed by your STIHL servicing dealer only. For example, if improper tools are used to remove the flywheel or if an improper tool is used to hold the flywheel in order to remove the clutch, structural damage to the flywheel could occur and could subsequently cause the flywheel to burst.

Wear gloves when handling or performing maintenance on saw chains.

! WARNING

Use the specified spark plug and make sure it and the ignition lead are always clean and in good condition. Always press spark plug boot snugly onto spark plug terminal of the proper size. (Note: If terminal has detachable SAE adapter nut, it must be securely attached.) A loose connection between spark plug terminal and the ignition wire connector in the boot may create arcing that could ignite combustible fumes and cause a fire.

! WARNING

Never test the ignition system with the spark plug boot removed from the spark plug or with a removed spark plug, since uncontained sparking may cause a fire.

! WARNING

Do not operate your power tool if the muffler is damaged, missing or modified. An improperly maintained muffler will increase the risk of fire and hearing loss. Your muffler is equipped with a spark-arresting screen to reduce the risk of fire; never operate your power tool if the screen is missing, damaged or clogged. Remember that the risk of a brush or forest fire is greater in hot or dry weather.

In California, it is a violation of § 4442 or § 4443 of the Public Resources Code to use or operate gasoline-powered tools on forest-covered, brush-covered or grass-covered land unless the engine's exhaust system is equipped with a complying spark arrester that is maintained in effective working order. The owner/operator of this product is responsible for properly maintaining the spark arrester. Other states or governmental entities/agencies, such as the U.S. Forest Service, may have similar requirements. Contact your local fire agency or forest service for the laws or regulations relating to fire protection requirements.

Keep the chain, bar and sprocket clean; replace worn sprockets or chains. Keep the chain sharp. You can spot a dull chain when easy-to-cut wood becomes hard to cut and burn marks appear on the wood. Keep the chain at proper tension.

Tighten all nuts, bolts and screws except the carburetor adjustment screws after each use.

WARNING

In order for the chain brake on your STIHL chain saw to properly perform its function of reducing the risk of kickback and other injuries, it must be properly maintained. Like an automobile brake, a chain saw chain brake incurs wear each time it is engaged.

The amount of wear will vary depending upon usage, conditions under which the saw is used and other factors. Excessive wear will reduce the effectiveness of the chain brake and can render it inoperable.

For the proper and effective operation of the chain brake, the brake band and clutch drum must be kept free of dirt, grease and other foreign matter which may reduce friction of the band on the drum.

For these reasons, each STIHL chain saw should be returned to trained personnel such as your STIHL servicing dealer for periodic inspection and servicing of the brake system according to the following schedule:

Heavy usage – every three months,
Moderate usage – twice a year,
Occasional usage – annually.

The chain saw should also be returned immediately for maintenance whenever the brake system cannot be thoroughly cleaned or there is a change in its operating characteristics.

For any maintenance of the emission control system please refer to the maintenance chart and to the limited warranty statement near the end of the instruction manual.

Do not clean your machine with a pressure washer. The solid jet of water may damage parts of the machine.

Store chain saw in a dry place and away from children. Before storing for longer than a few days, always empty the fuel tank (see chapter "Storing the Machine" in the instruction manual).

Reactive Forces

REACTIVE FORCES INCLUDING KICKBACK

WARNING

Reactive forces may occur any time the chain is rotating. Reactive forces can cause serious personal injury.

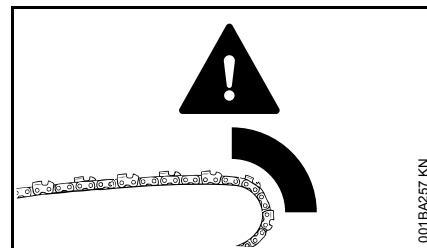

The powerful force used to cut wood can be reversed and work against the operator. If the rotating saw chain is suddenly and significantly slowed or stopped by contact with any solid object such as a log or branch or is pinched, the reactive forces may occur instantly. These reactive forces may result in loss of control, which, in turn, may cause serious or fatal injury. An understanding of the causes of these reactive forces may help you avoid the element of surprise and loss of control. Surprise contributes to accidents.

The most common reactive forces are:

- kickback,
- pushback,
- pull-in.

! WARNING

Kickback:



Kickback may occur when the moving saw chain near the upper quadrant of the bar nose contacts a solid object or is pinched.

When this occurs, the energy driving the saw chain can create a force that moves the chain saw in a direction opposite to the saw chain movement at the point where the saw chain is slowed or stopped. This may fling the bar up and back in a lightning fast reaction mainly in the plane of the bar and can cause severe or fatal injury to the operator.

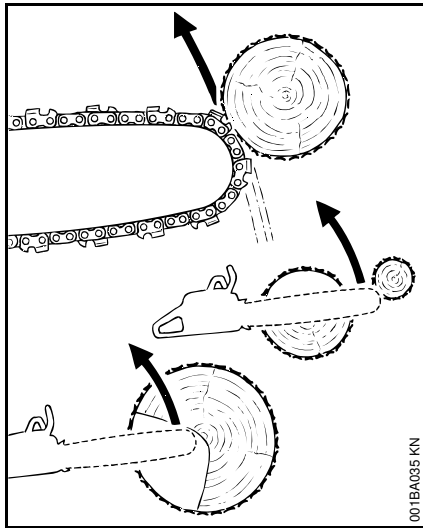

Kickback may occur, for example, when the saw chain near the upper quadrant of the bar nose contacts the wood or is

pinched during limbing or when it is incorrectly used to begin a plunge or boring cut.

The greater the force of the kickback reaction, the more difficult it becomes for the operator to control the chain saw. Many factors influence the occurrence and force of the kickback reaction. These include saw chain speed, the speed at which the bar and saw chain contact the object, the angle of contact, the condition of the saw chain and other factors.

The type of bar and saw chain you use is an important factor in the occurrence and force of the kickback reaction. Some STIHL bar and saw chain types are designed to reduce kickback forces. STIHL recommends the use of reduced kickback bars and low kickback chains.

Chain Saw Kickback Standard

The following standard apply with respect to kickback:

- § 5.11 of ANSI/OPEI B175.1-2012
- This standard, in the following referred to as "the chain saw kickback standard" sets certain performance and design criteria related to chain saw kickback.
- To comply with the chain saw kickback standard:
- a) Chain saws with a displacement of less than 3.8 cubic inches (62 cm³)

- must, in their original condition, meet a 45° computer derived kickback angle when equipped with certain cutting attachments,
 - and must be equipped with at least two devices to reduce the risk of kickback injury, such as a chain brake, low kickback saw chain, reduced kickback bar, etc.
- b) Chain saws with a displacement of 3.8 cubic inches (62 cm³) and above
- must be equipped with at least one device designed to reduce the risk of kickback injury, such as a chain brake, low kickback saw chain, reduced kickback bar, etc.

The computer derived angles for chain saws below 3.8 cubic inches (62 cm³) displacement are measured by applying a computer program to test results from a kickback test machine.

! WARNING

The computer derived angles of the chain saw kickback standard may bear no relationship to actual kickback bar rotation angles that may occur in real life cutting situations.

In addition, features designed to reduce kickback injuries may lose some of their effectiveness when they are no longer in their original condition, especially if they have been improperly maintained. Compliance with the chain saw kickback standard does not automatically mean that in a real life kickback the bar and saw chain will rotate at most 45°.

! WARNING

In order for chain saws below 3.8 cubic inches (62 cm³) displacement to comply with the computed kickback angle requirements of the chain saw kickback standard use only the following cutting attachments:

- bar and saw chain combinations listed as complying in the "Specifications" section of the instruction manual or
- other replacement bar and saw chain combinations marked in accordance with the standard for use on the chain saw or
- replacement saw chain designated "low kickback saw chain."

See the section on "Low Kickback Saw Chain and Reduced Kickback Bars."

Devices for Reducing the Risk of Kickback Injury

Stihl recommends the use of green labeled reduced kickback bars and low kickback saw chains on your chain saw equipped with a Stihl Quickstop chain brake.

! WARNING

To reduce the risk of injury, never use a chain saw if the chain brake does not function properly. Take the chain saw to your local STIHL servicing dealer. Do not use the chain saw until the problem has been rectified.

STIHL Quickstop Chain Brake

STIHL has developed a saw chain stopping system designed to reduce the risk of injury in certain kickback situations. It is called a Quickstop chain brake.

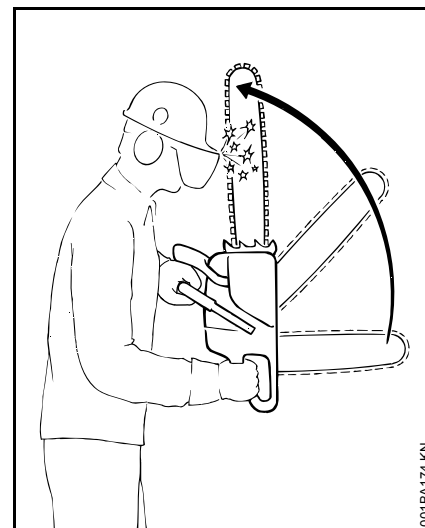

There are two mechanisms for activating the chain brake if it is in a properly maintained condition:

- manual activation: If a kickback occurs, the chain saw moves upwards towards the user in a rotating motion around the front handle. The brake is designed to engage if the left hand contacts the front guard, which is the activation lever for the brake, and pushes it forward.
- inertia activation: All STIHL chain saws are equipped with an inertia Quickstop chain brake. If the kickback impulse is strong enough, this alone is sufficient to engage the brake even without contacting the front hand guard.

! WARNING

Never operate your chain saw without a front hand guard. In a kickback situation this guard helps protect your left hand and other parts of your body. In addition, removal of the hand guard on a chain saw equipped with a Quickstop chain brake will disable the activation mechanism of the chain brake.

! WARNING

No Quickstop or other chain brake device prevents kickback. These devices are designed to reduce the risk of kickback injury, if activated, in certain kickback situations. In order for the Quickstop to reduce the risk of kickback injury, it must be properly maintained and in good working order. See the chapter of your instruction manual entitled "Chain Brake" and the section "Maintenance, Repair and Storing" at the end of these Safety Precautions. In addition, there must be enough distance between the bar and the operator to ensure that the Quickstop has sufficient time to activate and stop the chain before potential contact with the operator.

! WARNING

An improperly maintained chain brake may increase the time needed to stop the saw chain after activation, or may not activate at all.

! WARNING

Never run the chain saw above idle speed for more than 3 seconds when the chain brake is engaged or when the saw

chain is pinched or otherwise caught in the cut. Clutch slippage can cause excessive heat, leading to severe damage of the motor housing, clutch and oiler component and may interfere with the operation of the chain brake. If clutch slippage in excess of 3 seconds has occurred, allow the motor housing to cool before proceeding and check the operation of your chain brake as described in the chapter entitled "Chain Brake" of your instruction manual. Also make sure that the saw chain is not turning at idle speed (see above at "Important Adjustments").

Low Kickback Saw Chain and Reduced Kickback Bars

STIHL offers a variety of bars and saw chains. STIHL reduced kickback bars and low kickback saw chains are designed to reduce the risk of kickback injury. Other saw chains are designed to achieve higher cutting performance or sharpening ease, but in turn are more prone to kickback.

STIHL has developed a color code system to help you identify the STIHL reduced kickback bars and low kickback saw chains. Cutting attachments with green warning labels on the packaging are designed to reduce the risk of kickback injury. The matching of green marked or labeled chain saws under 3.8 cubic inches (62 cm³) displacement with green labeled bars and green labeled saw chains gives compliance with the computed kickback angle requirements of the chain saw standard when the products are in their original condition. Products with yellow labels are for users with extraordinary cutting

needs, having experience and specialized training for dealing with kickback.

STIHL recommends the use of its green labeled reduced kickback bars, green labeled low kickback saw chains and a chain saw equipped with a STIHL Quickstop chain brake for both experienced and inexperienced chain saw users.

Please ask your STIHL dealer to properly match your chain saw with the appropriate bar / saw chain combination to reduce the risk of kickback injury. Green labeled bars and saw chains are recommended for all chain saws.

! WARNING

Use of other, non-listed bar / saw chain combinations may increase kickback forces and the risk of kickback injury. New bar / saw chain combinations may be developed after publication of this literature, which will, in combination with certain chain saws, comply with the chain saw standard as well. Check with your STIHL dealer for such combinations.

! WARNING

Reduced kickback bars and low kickback saw chains do not prevent kickback, but they are designed to reduce the risk of kickback injury. They are available from your STIHL dealer.

! WARNING

Even if your saw is equipped with a Quickstop, a reduced kickback bar and / or low kickback saw chain, this does not

eliminate the risk of injury by kickback. Therefore, always observe all safety precautions to avoid kickback situations.

Low Kickback Saw Chain

Some types of saw chains have specially designed components to reduce the force of nose contact kickback. STIHL has developed low kickback saw chain for your chain saw.

A "low kickback saw chain" is a saw chain that has met the kickback performance requirements of ANSI/OPEI B175.1-2012 when tested according to the provisions specified in ANSI/OPEI B175.1-2012.

WARNING

There are potential chain saw and bar combinations with which low kickback saw chains can be used which have not been specifically certified to comply with the 45° computer derived kickback angle of the chain saw standard. Some low kickback saw chains have not been tested with all chain saw and bar combinations.

WARNING

A blunt or incorrectly sharpened saw chain may reduce or negate the effects of the design features intended to reduce kickback energy. Improper lowering or sharpening of the depth gauges as well as changing the shape of the cutters may increase the risk and the energy of kickback. Always cut with a properly sharpened saw chain.

Reduced Kickback Bars

STIHL green labeled reduced kickback bars are designed to reduce the risk of kickback injury when used with STIHL green labeled low kickback saw chains.

WARNING

When used with other, more aggressive saw chains, these bars may be less effective in reducing kickback.

WARNING

For a properly balanced saw and in order to comply with the chain saw standard, use only bar lengths listed in the specifications chapter of the instruction manual for your chain saw.

To avoid kickback

The best protection from personal injury that may result from kickback is to avoid kickback situations:

1. Hold the chain saw firmly with both hands and maintain a secure grip. Don't let go.
2. Be aware of the location of the guide bar nose at all times.
3. Never let the nose of the guide bar contact any object. Do not cut limbs with the nose of the guide bar. Be especially careful near wire fences and when cutting small, tough limbs, small size brush and saplings which may easily catch the saw chain.
4. Don't overreach.
5. Don't cut above shoulder height.
6. Begin cutting and continue at full throttle.

7. Cut only one log at a time.
8. Use extreme caution when reentering a previous cut.
9. Do not attempt to plunge cut if you are not experienced with these cutting techniques.
10. Be alert for shifting of the log or other forces that may cause the cut to close and pinch the saw chain.
11. Maintain saw chain properly. Cut with a correctly sharpened, properly tensioned saw chain at all times.
12. Stand to the side of the cutting path of the chain saw.

Bow Guides

WARNING

Do not mount a bow guide on any STIHL chain saw. Any chain saw equipped with a bow guide is potentially very dangerous. The risk of kickback is increased with a bow guide because of the increased kickback contact area. Low kickback saw chain will not significantly reduce the risk of kickback injury when used on a bow guide.

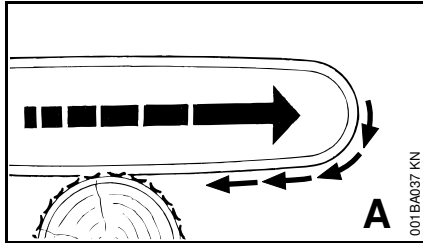
A = Pull-in

Pull-in occurs when the saw chain on the bottom of the bar is suddenly stopped when it is pinched, caught or encounters a foreign object in the wood. The reaction of the saw chain pulls the chain saw forward and may cause the operator to lose control.

Pull-in frequently occurs when the bumper spike of the chain saw is not held securely against the tree or limb and when the saw chain is not rotating at full speed before it contacts the wood.

! WARNING

Use extreme caution when cutting small size brush and saplings which may easily catch the saw chain, be whipped towards you or pull you off balance.

To avoid pull-in

1. Always start a cut with the saw chain rotating at full speed and the bumper spike in contact with the wood.
2. The risk of pull-in may also be reduced by using wedges to open the kerf or cut.

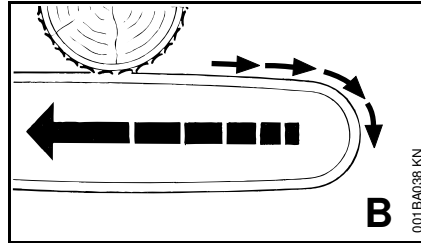
B = Pushback

Pushback occurs when the saw chain on the top of the bar is suddenly stopped when it is pinched, caught or encounters a foreign object in the wood. The reaction of the saw chain may drive the chain saw rapidly straight back toward the operator and may cause loss of chain saw control, which, in turn, may cause serious or fatal injury. Pushback frequently occurs when the top of the bar is used for cutting.

To avoid pushback

1. Be alert to forces or situations that may cause material to pinch the top of the saw chain.
2. Do not cut more than one log at a time.
3. Do not twist the chain saw when withdrawing the bar from a plunge cut or underbuck cut because the saw chain can pinch.

Working Techniques

Limbing

Limbing is removing the branches from a fallen tree.

! WARNING

There is an extreme danger of kickback during the limbing operation. Do not work with the nose of the bar. Be extremely cautious and avoid contacting the log or other limbs with the nose of the guide bar.

Do not stand on a log while limbing it – you may slip or the log may roll.

Start limbing by leaving the lower limbs to support the log off the ground. When underbucking freely hanging limbs, a pinch may result or the limb may fall, causing loss of control. If a pinch occurs, stop the engine and remove the saw by lifting the limb.

! WARNING

Be extremely cautious when cutting limbs or logs under tension (spring poles). The limbs or logs could spring back toward the operator and cause loss of control of the saw and severe or fatal injury to the operator.

Bucking

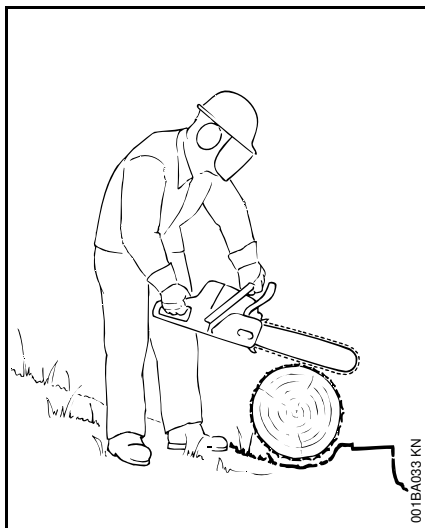

Bucking is cutting a log into sections.

! WARNING

When bucking, do not stand on the log. Make sure the log will not roll downhill. If on a slope, stand on the uphill side of the log. Watch out for rolling logs.

Cut only one log at a time.

Shattered wood should be cut very carefully. Sharp slivers of wood may be caught and flung in the direction of the operator of the saw.

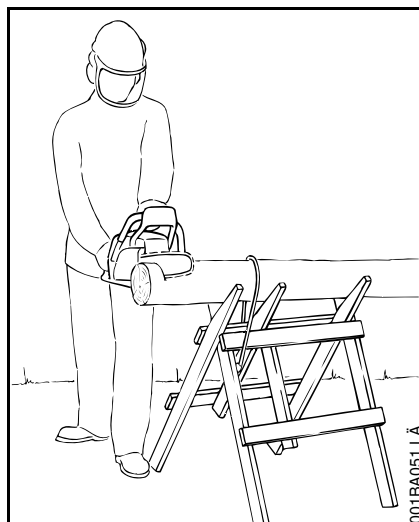

When cutting small logs, place log through "V"-shaped supports on top of a sawhorse. Never permit another person to hold the log. Never hold the log with your leg or foot.

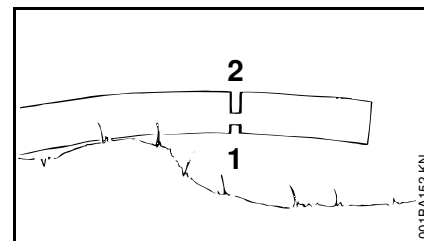
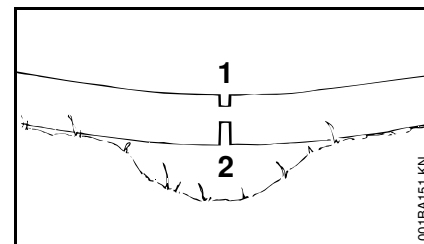

Logs under strain:

Risk of pinching! Always start relieving cut (1) at compression side. Then make bucking cut (2) at tension side. If the saw pinches, stop the engine and remove it from the log.

Only properly trained professionals should work in an area where the logs, limbs and roots are tangled. Working in "blow down" areas is extremely hazardous. Drag the logs into a clear area before cutting. Pull out exposed and cleared logs first.

Felling

Felling is cutting down a tree.

Before felling a tree, consider carefully all conditions which may affect the direction of fall.

! WARNING

There are a number of factors that may affect and change the intended direction of fall, e.g. wind direction and speed, lean of tree, surrounding trees and obstacles, sloping ground, one-sided limb structure, wood structure, decay, snow load, etc. To reduce the risk of severe or fatal injury to yourself or others, look for these conditions prior to beginning the cut, and be alert for a change in direction while the tree is falling.

! WARNING

Always observe the general condition of the tree. Inexperienced users should never attempt to cut trees that are decayed or rotted inside or that are leaning or otherwise under tension. There is an increased risk that such trees could snap or split while being cut and cause serious or fatal injury to the operator or bystanders. Also look for broken or dead branches which could vibrate loose and fall on the operator. When felling on a slope, the operator should stand on the uphill side if possible.

Felling Instructions

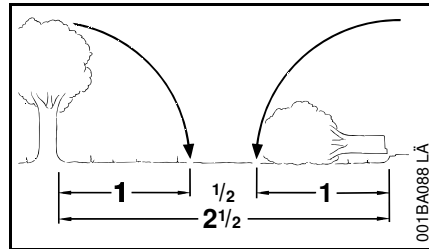

When felling, maintain a distance of at least 2 1/2 tree lengths from the nearest person.

When felling in the vicinity of roads, railways and power lines, etc., take extra precautions. Inform the police, utility company or railway authority before beginning to cut.

! WARNING

The noise of your engine may drown any warning call.

Escape Path

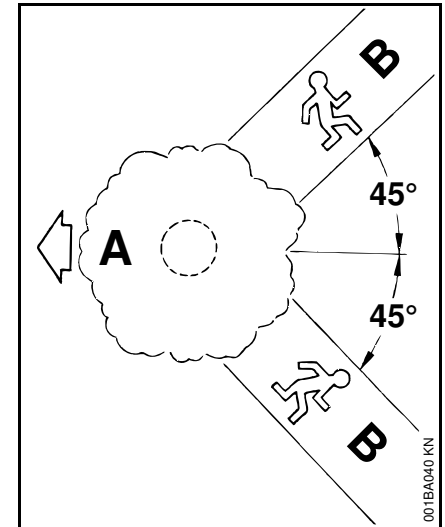

First clear the tree base and work area from interfering limbs and brush and clean its lower portion with an ax.

Then, establish two paths of escape (B) and remove all obstacles. These paths should be generally opposite to the planned direction of the fall of the tree (A) and about at a 45° angle. Place all tools and equipment a safe distance away from the tree, but not on the escape paths.

Buttress Roots

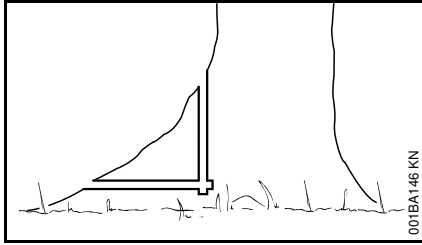

If the tree has large buttress roots, cut into the largest buttress vertically first (horizontally next) and remove the resulting piece.

Gunning Sight

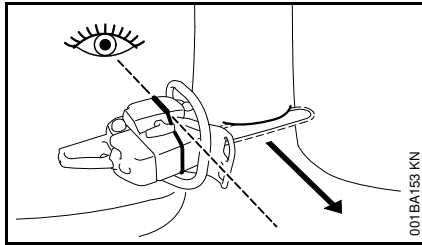

When making the felling notch, use the gunning sight on the shroud and housing to check the desired direction of fall:

Position the saw so that the gunning sight points exactly in the direction you want the tree to fall.

Conventional Cut

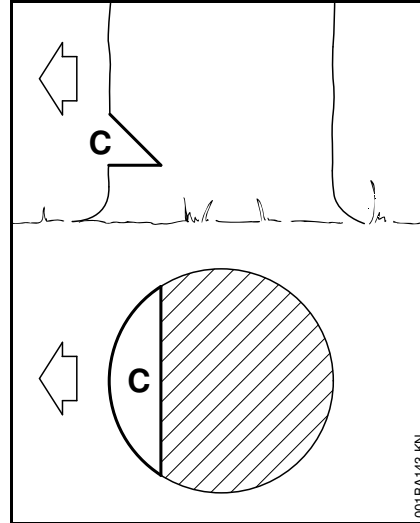

Felling notch (C) – determines the direction of the fall

For a conventional cut:

- Properly place felling notch perpendicular to the line of fall, close to the ground.
- Cut down at approx. 45° angle to a depth of about 1/5 to 1/4 of the trunk diameter.
- Make second cut horizontal.
- Remove resulting 45° piece.

Open-face Technique

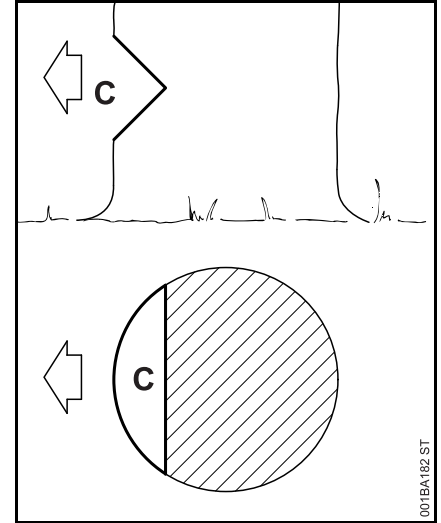

Felling notch (C) – determines the direction of the fall

For an open-face cut:

- Properly place felling notch perpendicular to the line of fall, close to the ground.
- Cut down at approx. 50° angle to a depth of approx. 1/5 to 1/4 of the trunk diameter.
- Make second cut from below at approx. 40 degree angle.
- Remove resulting 90° piece.

Making Sapwood Cuts

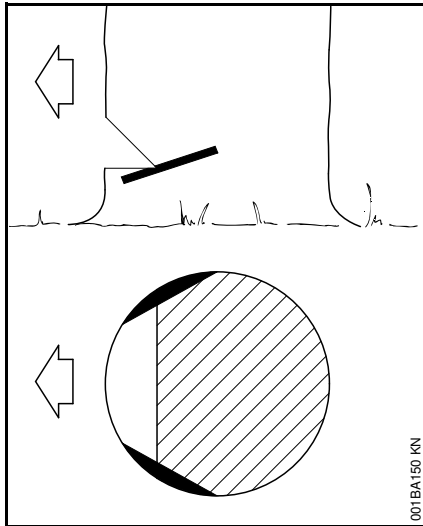

- For medium sized or larger trees make cuts at both sides of the trunk, at same height as subsequent felling cut.
- Cut to no more than width of guide bar.

This is especially important in softwood in summer – it helps prevent sapwood splintering when the tree falls.

D = Felling Cut

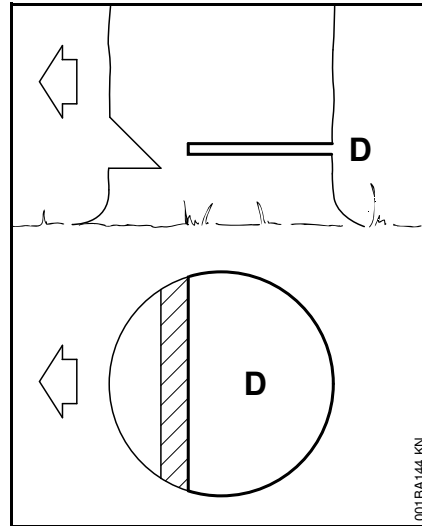

Conventional and open-face technique:

- Begin 1 to 2 inches (2,5 to 5 cm) higher than center of felling notch.
- Cut horizontally towards the felling notch.
- Leave approx. 1/10 of diameter uncut. This is the hinge.
- Do not cut through the hinge – you could lose control of the direction of the fall.

Drive wedges into the felling cut where necessary to control the fall.

WARNING

If the tip of the bar contacts a wedge, it may cause kickback. Wedges should be of wood or plastic – never steel, which can damage the chain.

E = Hinge

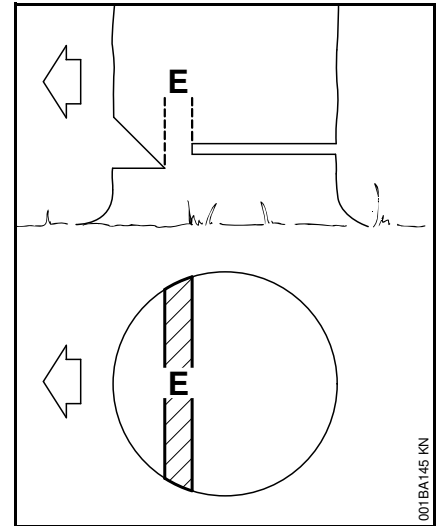

- Helps control the falling tree.
- Do not cut through the hinge – you could lose control of the direction of the fall.

Felling Cut for Small Diameter Trees: Simple Fan Cut

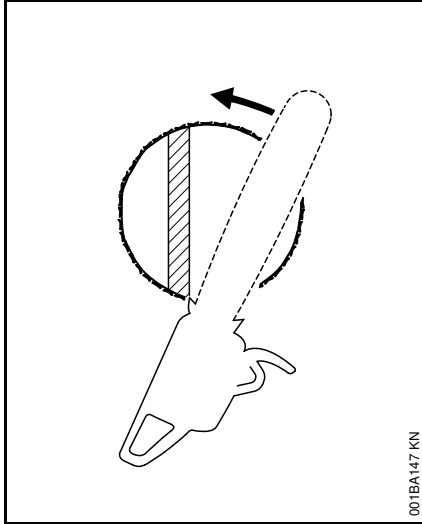

Engage the bumper spikes of the chain saw directly behind the location of the intended hinge and pivot the saw around this point only as far as the hinge. The bumper spike rolls against the trunk.

Felling Cut for Large Diameter Trees

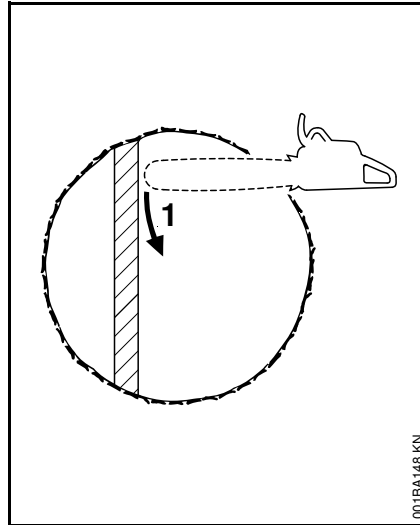

! WARNING

Felling a tree that has a diameter greater than the length of the guide bar requires use of either the sectioning felling cut or plunge-cut method. These methods are extremely dangerous because they involve the use of the nose of the guide bar and can result in kickback. Only properly trained professionals should attempt these techniques.

Sectioning Method

For the sectioning method make the first part of the felling cut with the guide bar fanning in toward the hinge. Then, using the bumper spike as a pivot, reposition the saw for the next cut.

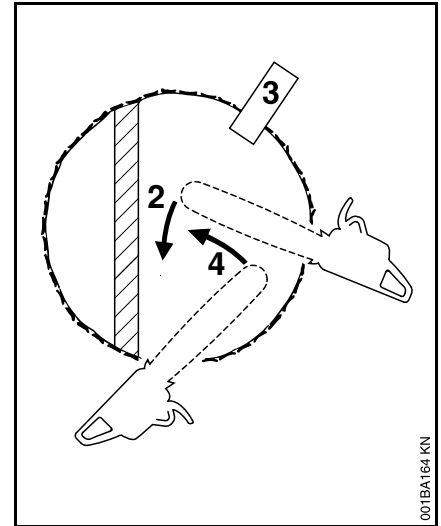

Avoid repositioning the saw more than necessary. When repositioning for the next cut, keep the guide bar fully engaged in the kerf to keep the felling cut straight. If the saw begins to pinch, insert a wedge to open the cut. On the last cut, do not cut the hinge.

Plunge-cut Method

Timber having a diameter more than twice the length of the guide bar requires the use of the plunge-cut method before making the felling cut.

First, cut a large, wide felling notch. Make a plunge cut in the center of the notch.

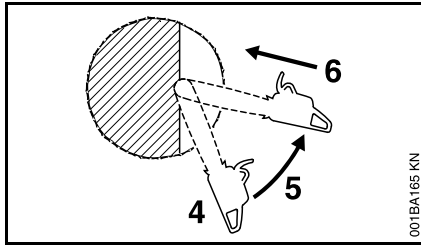

The plunge cut is made with the guide bar nose. Begin the plunge cut by applying the lower portion of the guide bar nose to the tree at an angle. Cut until the depth of the kerf is about the same as the width of the guide bar. Next, align the saw in the direction in which the recess is to be cut.

With the saw at full throttle, insert the guide bar in the trunk.

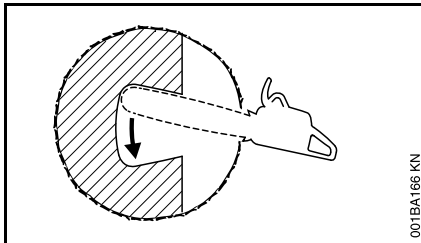

Enlarge the plunge cut as shown in the illustration.

! WARNING

There is an extreme danger of kickback at this point. Extra caution must be taken to maintain control of the saw. To make the felling cut, follow the sectioning method described previously.

If you are inexperienced with a chain saw, plunge-cutting should not be attempted. Seek the help of a professional.

! WARNING

In order to reduce the risk of personal injury, never stand directly behind the tree when it is about to fall, since part of the trunk may split and come back towards the operator (barber-chairing), or the tree may jump backwards off the stump. Always keep to the side of the falling tree. When the tree starts to fall, withdraw the bar, shut off the engine and walk away on the preplanned escape path. Watch out for falling limbs.

! WARNING

Be extremely careful with partially fallen trees which are poorly supported. When the tree hangs or for some other reason does not fall completely, set the saw aside and pull the tree down with a cable winch, block and tackle or tractor. If you try to cut it down with your saw, you may be injured.

Maintenance and Care

The following maintenance intervals apply for normal operating conditions only. When working under difficult conditions (high accumulation of dust, highly resinous lumber, lumber from tropical trees, etc.) or longer than normal each day, the specified intervals must be shortened accordingly. If you only use the tool occasionally, extend the intervals accordingly.		Before starting work	At the end of work and/or daily	Whenever tank is refilled	Weekly	Monthly	Annually	If faulty	If damaged	As required
Complete machine	Visual inspection (condition, leaks)	X		X						
	Clean		X							
Throttle trigger, throttle trigger lockout, choke lever, stop switch, master control lever (dependent on equipment)	Function test	X		X						
Chain brake	Function test	X		X						
	Have checked by dealer ¹⁾									X
Manual fuel pump (if present)	check	X								
	Have repaired by a specialist dealer ¹⁾								X	
Fuel pick-up body / filter in fuel tank	check					X				
	Clean, replace filter insert					X		X		
	replace						X		X	X
Fuel tank	Clean					X				
Lubricating oil tank	Clean					X				
Chain lubrication	check	X								
Saw chain	Check, pay attention to sharpness	X		X						
	Checking the chain tension	X		X						
	sharpen									X
Guide bar	Check (wear, damage)	X								
	Clean and turn over									X
	Deburr				X					
	replace								X	X
Chain sprocket	check				X					
Air filter	Clean							X		X
	replace								X	

The following maintenance intervals apply for normal operating conditions only. When working under difficult conditions (high accumulation of dust, highly resinous lumber, lumber from tropical trees, etc.) or longer than normal each day, the specified intervals must be shortened accordingly. If you only use the tool occasionally, extend the intervals accordingly.		Before starting work	At the end of work and/or daily	Whenever tank is refilled	Weekly	Monthly	Annually	If faulty	If damaged	As required
Anti-vibration elements	check	X						X		
	Have replaced by servicing dealer ¹⁾								X	
Air intake on fan housing	Clean		X		X					X
Cylinder fins	Clean		X			X				
Carburetor	Check idle adjustment – saw chain must not rotate	X		X						
	Set the idle speed; if required have the chainsaw repaired by a specialist dealer ¹⁾									X
Spark plug	Adjust electrode gap							X		
	Replace after 100 hours of operation									
Accessible screws and nuts (except adjusting screws)	Tighten ²⁾									X
Spark arresting screen in muffler	Have checked by dealer ¹⁾							X		
	Have cleaned; if required have replaced by specialist dealer ¹⁾								X	
Chain catcher	check	X								
	replace								X	
Safety information label	replace								X	

1) STIHL recommends STIHL servicing dealer

2) When using professional chainsaws (with a power output of 3.4 kW or more) for the first time, tighten the cylinder block screws after 10 to 20 hours of operation

Main Parts

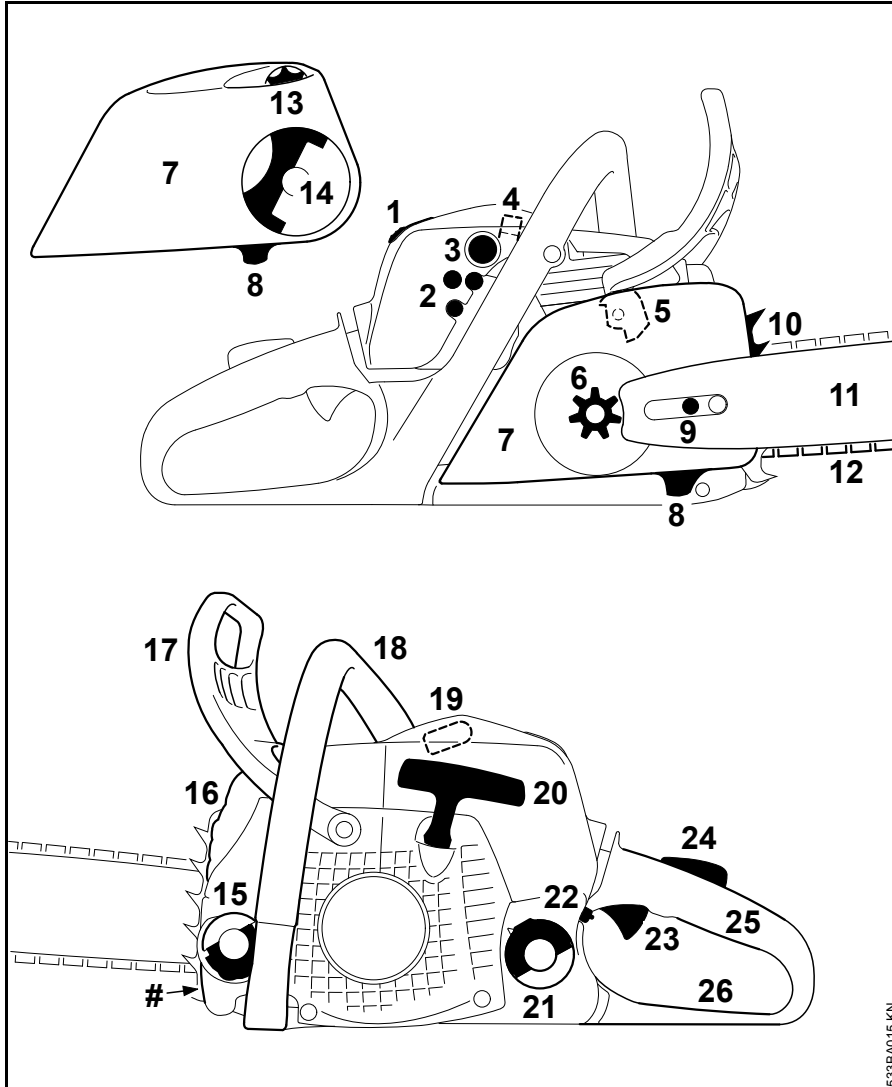

- 1 Shroud Twist Lock
- 2 Carburetor Adjusting Screws
- 3 Manual Fuel Pump (Easy Start¹⁾)
- 4 Shutter (Summer and Winter Position, only MS 211)
- 5 Chain Brake
- 6 Chain Sprocket
- 7 Chain Sprocket Cover
- 8 Chain Catcher
- 9 Chain Tensioner (lateral)
- 10 Bumper Spike
- 11 Guide Bar
- 12 Oilomatic Saw Chain
- 13 Adjusting Wheel for Quick Chain Tensioner¹⁾
- 14 Handle of Wingnut (Quick Chain Tensioner¹⁾)
- 15 Oil Filler Cap
- 16 Muffler
- 17 Front Hand Guard
- 18 Front Handle (Handlebar)
- 19 Spark Plug Boot
- 20 Starter Grip
- 21 Fuel Filler Cap
- 22 Master Control Lever
- 23 Throttle Trigger
- 24 Throttle Trigger Lockout
- 25 Rear Handle
- 26 Rear Hand Guard
- # Serial Number

¹⁾ Depending on Model

Definitions

- 1 Shroud Twist Lock**
Lock for shroud.
 - 2 Carburetor Adjusting Screws**
For tuning the carburetor.
 - 3 Manual Fuel Pump**
Provides additional fuel feed for a cold start.
 - 4 Shutter**
With summer and winter positions. Carburetor is heated in winter position.
 - 5 Chain Brake**
A device to stop the rotation of the chain. Is activated in a kickback situation by the operator's hand or by inertia.
 - 6 Chain Sprocket**
The toothed wheel that drives the saw chain.
 - 7 Chain Sprocket Cover**
Covers the clutch and chain sprocket.
 - 8 Chain Catcher**
Helps to reduce the risk of operator contact by a chain if it breaks or comes off the bar.
 - 9 Chain Tensioner (lateral)**
Permits precise adjustment of chain tension.
 - 10 Bumper Spike**
Toothed stop for holding saw steady against wood.
 - 11 Guide Bar**
Supports and guides the saw chain.
 - 12 Oilomatic Saw Chain**
A loop consisting of cutters, tie straps and drive links.
 - 13 Adjusting Wheel for Quick Chain Tensioner**
Permits precise adjustment of chain tension.
 - 14 Handle of Wingnut (Quick Chain Tensioner)**
Must be released to allow chain to be tensioned with adjusting wheel.
 - 15 Oil Filler Cap**
For closing the oil tank.
 - 16 Muffler**
Reduces engine exhaust noise and diverts exhaust gases away from operator.
 - 17 Front Hand Guard**
Provides protection against projecting branches and helps prevent left hand from touching the chain if it slips off the handlebar. It also serves as the lever for chain brake activation.
 - 18 Front Handle (Handlebar)**
Handlebar for the left hand at the front of the saw.
 - 19 Spark Plug Boot**
Connects the spark plug with the ignition lead.
 - 20 Starter Grip**
The grip of the pull starter, for starting the engine.
 - 21 Fuel Filler Cap**
For closing the fuel tank.
 - 22 Master Control Lever**
Lever for choke control, starting throttle, run and stop switch position.
 - 23 Throttle Trigger**
Controls the speed of the engine.
 - 24 Throttle Trigger Lockout**
Must be depressed before the throttle trigger can be activated.
 - 25 Rear Handle**
The support handle for the right hand, located at the rear of the saw.
 - 26 Rear Hand Guard**
Gives added protection to operator's right hand.
- Guide Bar Nose**
The exposed end of the guide bar. (not illustrated, see chapter "Tensioning the Saw Chain")
- Clutch**
Couples engine to chain sprocket when engine is accelerated beyond idle speed. (not illustrated)
- Anti-Vibration System**
The anti-vibration system includes a number of anti-vibration elements designed to reduce the transmission of vibrations created by the engine and cutting attachment to the operator's hands. (not illustrated)

 **WARNING**

The engine exhaust from this product contains chemicals known to the State of California to cause cancer, birth defects or other reproductive harm.

0457-184-3021

englisch USA



www.stihl.com



0457-184-3021